



# Production Booklet

for the

## PRESTI SPA



2800 Richter Ave. Suite C, Oroville, CA 95965 • **voice:** (530)534-9910

**email:** [jim@tiledspas.com](mailto:jim@tiledspas.com) • **website:** [www.tiledspas.com](http://www.tiledspas.com)

# RECOMMENDED MAINTENANCE

## *Please Note:*

These are only recommended guidelines to care for a Nespa all tiled spa. Local codes may require additional procedures, therefore consult with a pool professional that is LA county Health Department certified for more information on local codes and requirements.

## *SPA SURFACE*

Your spa tile is acid resistant and frost-proof. The Tile does not absorb germs or algae. Tile does not stain and is very easy to clean. Color does not fade or lose its luster. All grouts are epoxy based and are extremely durable. To remove scum line use soft nylon brush and small amounts of biodegradable soaps. Do not use abrasive brushes or chemicals.

## *MAINTENANCE*

---

### **A. CHEMICALS:**

- 1) It is important to maintain a chlorine residual of 2 PPM in the spa. That residual can be provided by chlorine or bromine.
- 2) It is recommended to use Bromine or dichlor (granular) forms of chlorine. If bromine Tabs are used we suggest floating or inline dispenser.
- 3) Never use acid to lower Ph in the tile spa.
- 4) Never use trichlor chlorine (1" or 3") tablets in the Nespa spas.
- 5) Never place tablets in skimmer basket.

### **B. DRAINING THE SPA:**

- 1) It is recommended to drain the spa at least once every 2 months depending on bath load and water clarity.
- 2) The spa should be drained through valve exiting re-circulation pump in the spa equipment room or sump pump.
- 3) Note: Use caution to drain spa in the winter months or rainy season when water table is at its highest. It is possible for the spa to float due to hydraulic pressure from surrounding water table. We advise that you consult with your local spa specialist prior to draining the spa.

### **C. SPA EQUIPMENT:**

- 1) Clean filter cartridge at least once every month, or when needed; i.e., if water clarity does not improve after several days.
- 2) Keep area free and clear from leaves and debris build-up.
- 3) Keep area free and clear from flooding.

### **D. SPA LIGHT:**

- 1) Spa light has to be on GFCI circuit. It is controlled at spa side with ON/OFF.

### **E. TILE SERVICING:**

- 1) Contact manufacture when servicing tile or grout. @ (530) 534-9910

## NESPA DRAWING SET

### 1. SPA PLAN

Spa width and length, Interior EQ locations, Step & Bench configuration

### 2. SECTIONS

Spa Height, Interior EQ locations

Jet Details

### 3. TILE

**Tile types and locations, grout and transition details**

### 4. SPA FITTINGS

**Interior** spa equipment

### 5. SPA EQUIPMENT

**Exterior** spa equipment

### 6&7. SPA PLUMBING

Suction Plumbing, Return Plumbing  
and Equipment list and Schematic

### 8. AUTO COVER

Plan and Section on-site location

### 9. COVER

## PLAN APPROVAL DOCUMENTATION

Nespa's design and structural manufacturing departments may find it necessary to make slight adjustments (< 1") to your spa.

This may include the size of the spa (OD/ID), tile cuts, depths, jet location, bench steps etc. These adjustments must be made in the primary stages of building the spa.

The adjustments are generally made to ad structural and aesthetic integrity to the vessel. IE: balance of supporting gussets (exterior) and less tile cuts / symmetrical cuts, grout lines, etc. (interior)

**Please initial next to the following number that describes your project needs.**

- \_\_\_\_\_ 1. **YES**, I understand adjustments need to be made. Nespa will use their expertise to make these adjustments as needed.  
I give them the authority to make changes.  
I will receive final accurate drawings prior to receipt of spa or spa hole construction (if changes were made to the size)
- \_\_\_\_\_ 2. **NO**, No changes can be made even under 1". Dimensions are fixed.  
More tile cuts may be needed. Structural supports may be altered to accommodate.
- \_\_\_\_\_ 3. **Nespa** will need to contact us for any changes to spa dimensions prior to continued spa fabrication.

## APPROVAL

Purchaser is to provide protection to spa finish as well as plumbing during the installation phase. This includes rain, freeze and sun exposure.

Purchaser acknowledges that all previous drawings to this one submitted or discussed no longer apply. Purchaser accepts that all dimensions external to the Nespa product are purchaser's responsibility and that purchaser is responsible for the merging of Nespa product to job site conditions, all required dimensions and elevations and mechanical access. Purchaser also acknowledges that they are responsible for all code compliancy to the Nespa product.

Purchaser acknowledges that maintaining the spa level is critical. Purchaser will provide a level concrete platform surface for spa to sit upon. If shimming material is used purchaser will provide rigid non-compressible material.

**I approve the above drawings :**

\_\_\_\_\_ **Date:** \_\_\_\_\_

Any changes to these plans from here forward shall be directed in writing to Nespa.

**0**

**COVER PAGE**

**PRESTI**

SCALE: **N/A**



**NESPA ENTERPRISES INC.**

**6/19/2021**

# 12' Legacy

SPECIFICATIONS	
SHELL WEIGHT:	3000 LBS.
WATER WEIGHT:	10190 LBS.
TOTAL SHELL & WATER WEIGHT:	13189.7 LBS.
WATER VOLUME:	163.4 Cu.Ft.
WATER GALLONS:	1222 GAL.
SURFACE AREA:	72.0 SQ. FT.
ICC ES LISTED #:	PMG-1161











NESPA ENTERPRISES, Inc.





ICC ES Listed  
PMG-1161

iS4 Spa Side Control

## LEGEND:

	SKIMMER	1
	MAIN DRAIN	2
	SUCTION	2
	JET	20
	RETURN	4
	WATER FILL	-
	STILLING	1
	VAC	-
	LIGHT	1
	iS4 Control	1

WATERPROOF SKID SUPPORT STRUCTURE ATTACHED TO SPA AT NESPA FACTORY

  \*SKIDS SUPPLIED BY NESPA

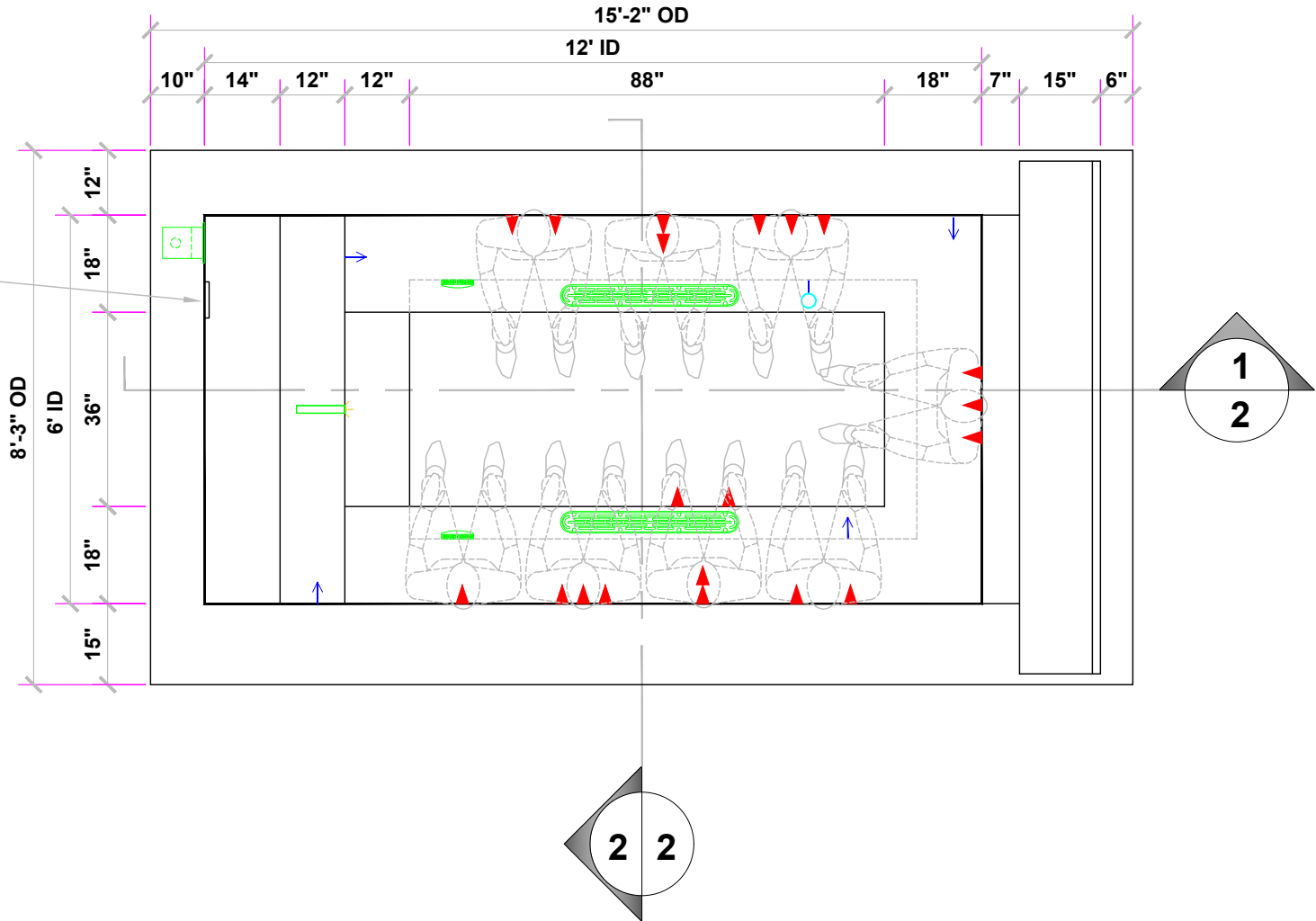

1

SD

PRESTI

SCALE: 3/8" = 1'



NESPA ENTERPRISES INC.

6/19/2021



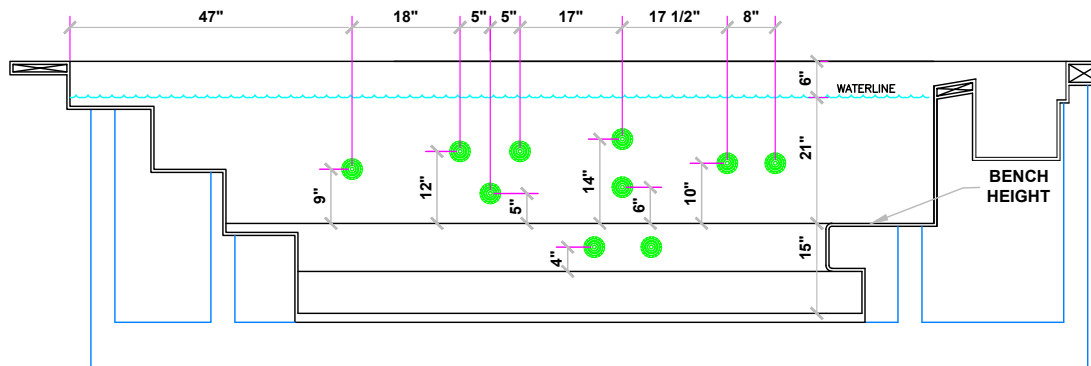
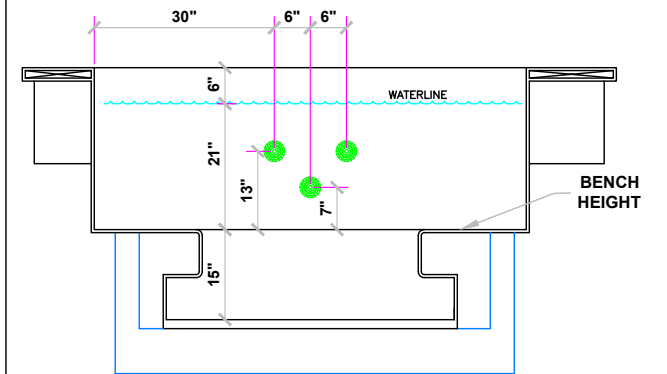
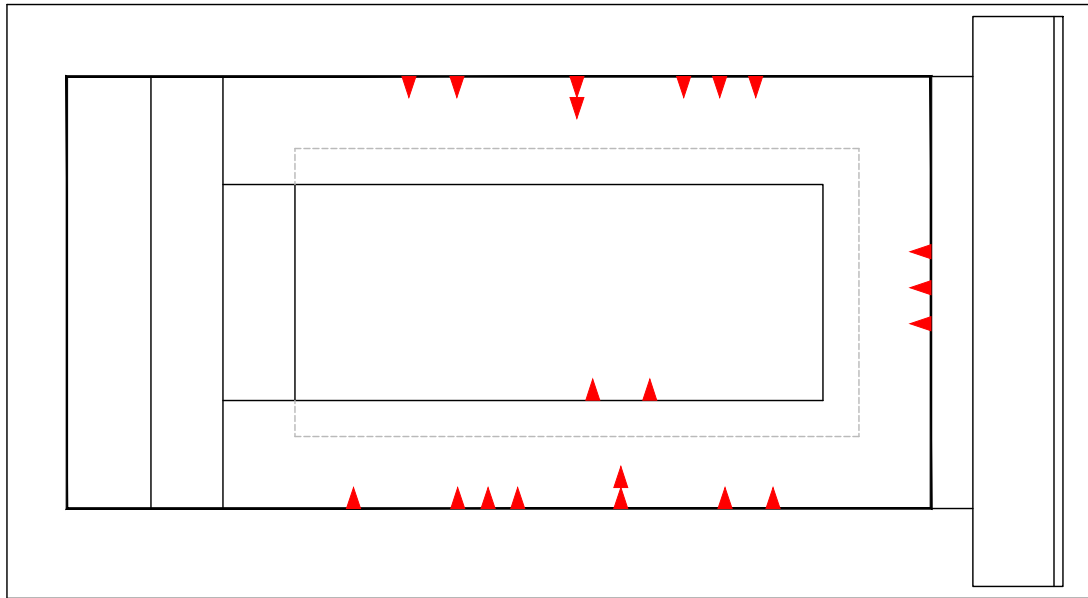
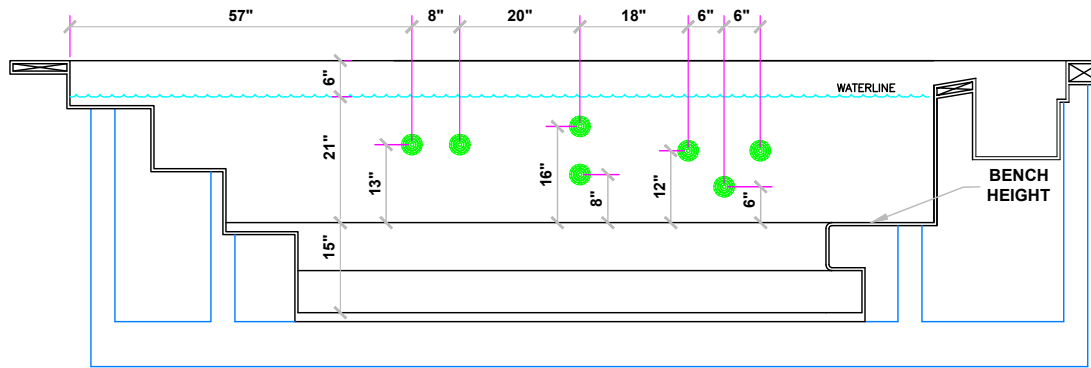

**2B**  
Jet Details

PRESTI

SCALE: 1/2" = 1'



NESPA ENTERPRISES INC.

6/19/2021

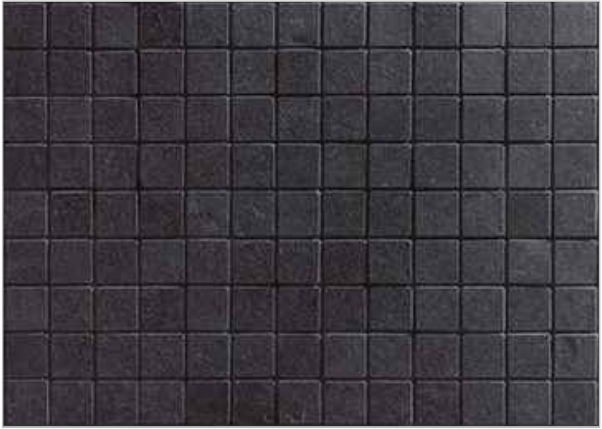

FIELD TILE Cornerstone - Slate Black Natural - 30x30cm - 12"x12"

APPROVED \_\_\_\_\_

Cornerstone - Slate Black Natural  
- 30x30cm - 12"x12"  
**201 Sq Ft**

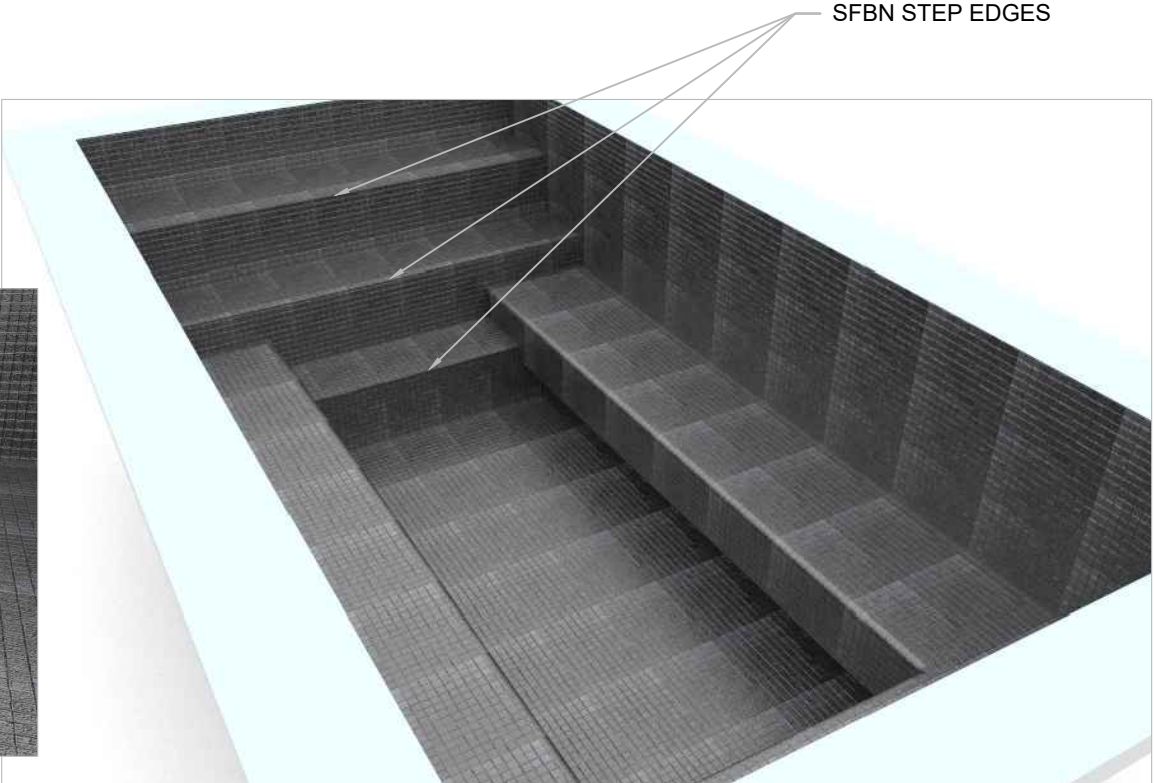
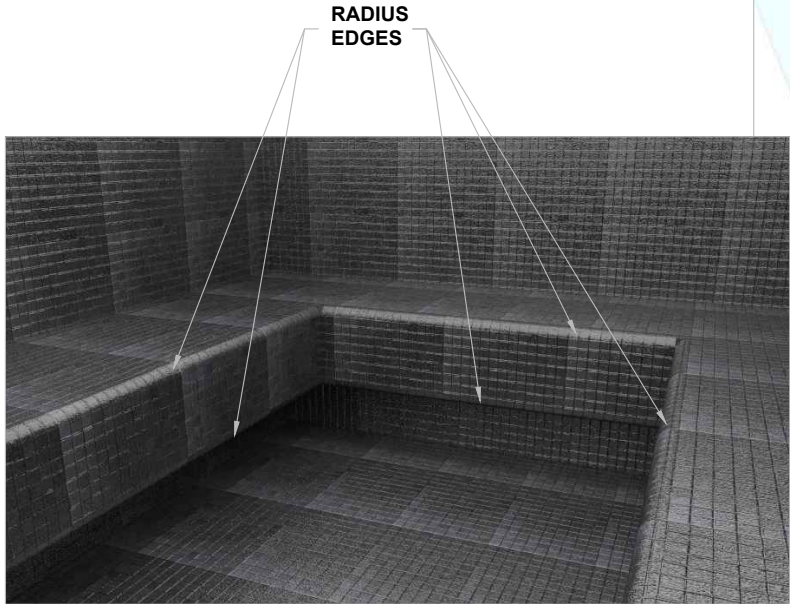

**3**  
TILE

**PRESTI**







SCALE: N/A

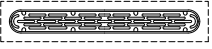

**NESPA ENTERPRISES INC.**

**6/19/2021**

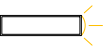
## EQUIPMENT LIST

ITEM	CODE	EQUIPMENT	DESCRIPTION	MANUFACTURER	CATALOG NO.	QTY.
1	SS		FRONT ACCESS SKIMMER, NSF APPROVED	HAYWARD	SP 1099s	1
3	MD		MAIN DRAIN: AQUASTAR 32CDFLFR, 32" CHANNEL DRAIN, Approved Max Flow Rate: Floor = 316 GPM @ 3.9 fps Complies w/ ANSI / ASME A112.19.8 & NSF / ANSI 16-2011 - V.G.B. APPROVED	AQUASTAR	32CDFLFR101	2
4	BS		6" Round Hockey puck - Sumless Suction Outlet Floor 177 GPM - Wall 122 GPM Complies w/ ANSI / ASME A112.19.8 & ANSI / APSF-16 for anti-hair and body entrapment Suction outlets comply with ANSI / APSP-7	AQUASTAR	6PHAxxx	2
5	J#		HYDRO JETS 1-1/2" WATER - 1-1/2" AIR Complies w/ ANSI / ASME A112.19.8 & ANSI / APSF-16 - UL APPROVED	HYDROAIR	10-5100	20
6	WI		INLET FITTINGS 1-1/2" WALL TYPE W/ EYEBALL COMPLIES W/ ANSI CODE ASME A112.19.8-07 UL APPROVED	HYDROAIR	10-3500	4
7	AF		AUTOFILL SENSOR	JANDY	Fluidra	1
8	UL		PENTAIR 12V 50' GLOBRITE LED LIGHT	PENTAIR	620424	1
9	CC		SPA SIDE CONTROL - iS4	PENTAIR	iS4	1

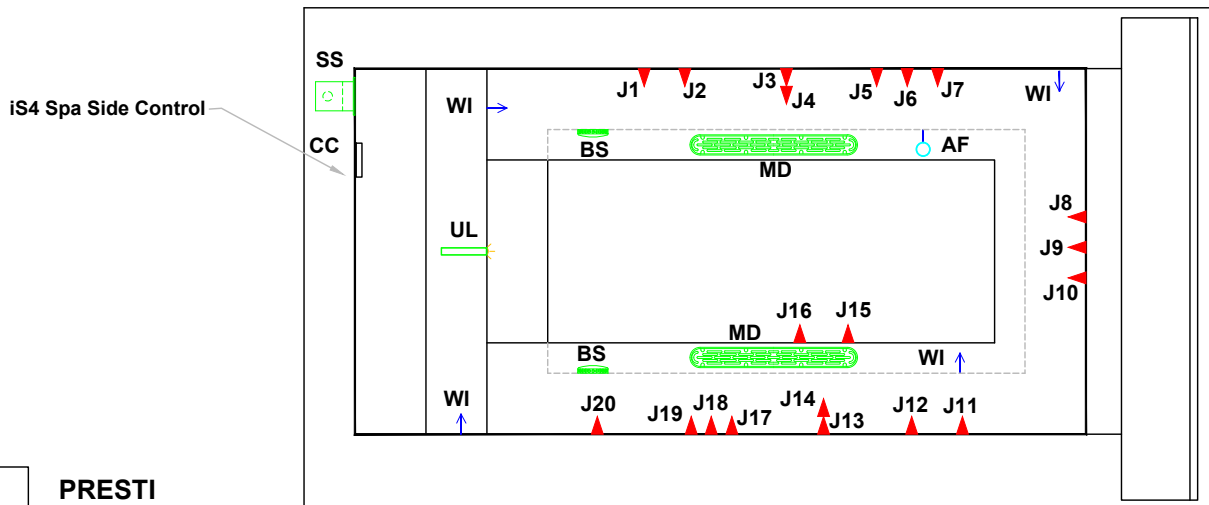

**4**

Spa Fittings

PRESTI

SCALE: N/A







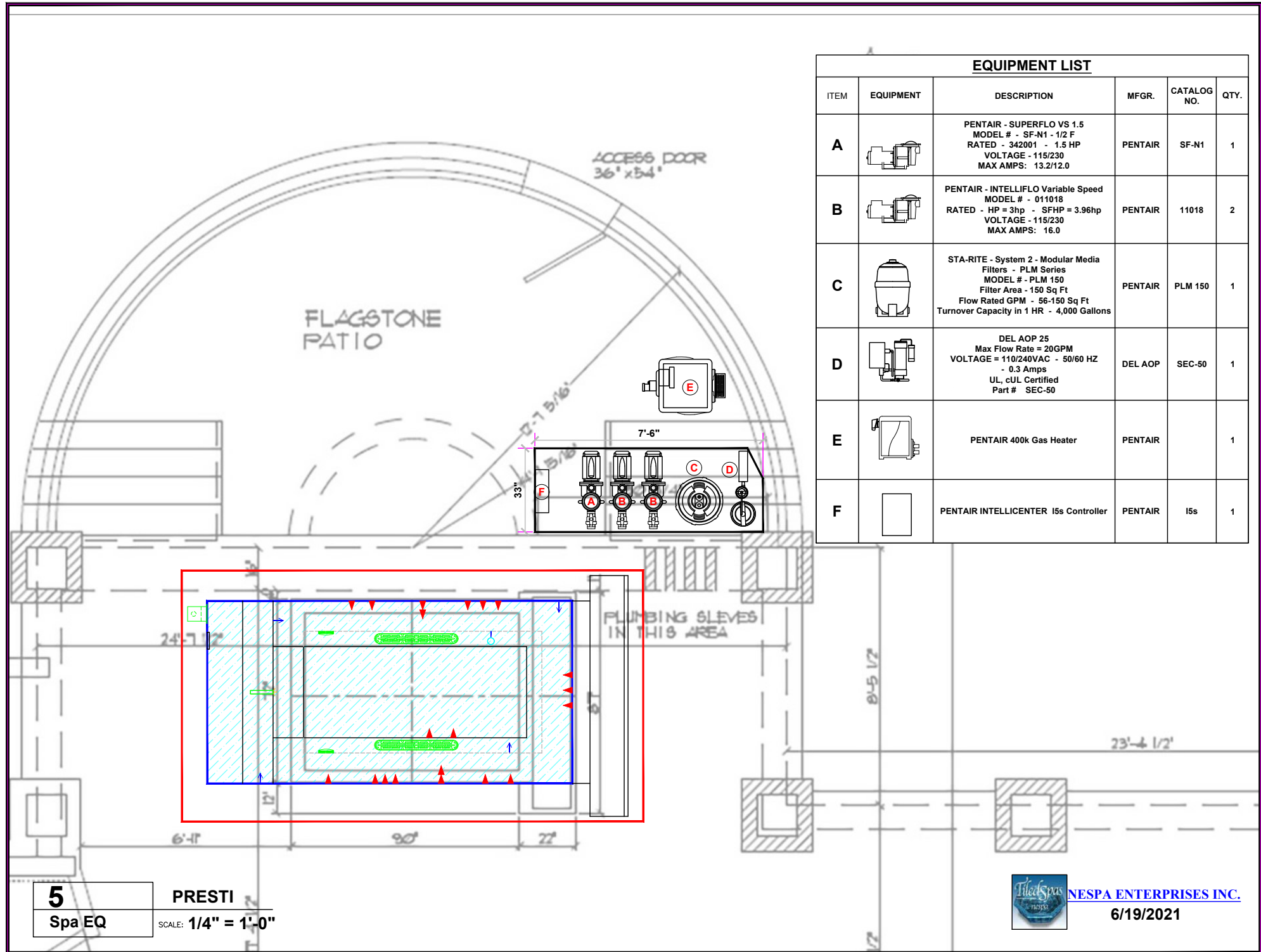

NESPA ENTERPRISES INC.

6/19/2021





EQUIPMENT LIST					
ITEM	EQUIPMENT	DESCRIPTION	MFGR.	CATALOG NO.	QTY.
A		PENTAIR - SUPERFLO VS 1.5 MODEL # - SF-N1 - 1/2 F RATED - 342001 - 1.5 HP VOLTAGE - 115/230 MAX AMPS: 13.2/12.0	PENTAIR	SF-N1	1
B		PENTAIR - INTELLIFLO Variable Speed MODEL # - 011018 RATED - HP = 3hp - SFHP = 3.96hp VOLTAGE - 115/230 MAX AMPS: 16.0	PENTAIR	11018	2
C		STA-RITE - System 2 - Modular Media Filters - PLM Series MODEL # - PLM 150 Filter Area - 150 Sq Ft Flow Rated GPM - 56-150 Sq Ft Turnover Capacity in 1 HR - 4,000 Gallons	PENTAIR	PLM 150	1
D		DEL AOP 25 Max Flow Rate = 20GPM VOLTAGE = 110/240VAC - 50/60 HZ - 0.3 Amps UL, cUL Certified Part # SEC-50	DEL AOP	SEC-50	1
E		PENTAIR 400k Gas Heater	PENTAIR		1
F		PENTAIR INTELLICENTER I5s Controller	PENTAIR	I5s	1

**5**  
Spa EQ

**PRESTI**  
SCALE: 1/4" = 1'-0"



[NESPA ENTERPRISES INC.](http://www.nespaenterprises.com)  
6/19/2021

FLAGSTONE  
PATIO

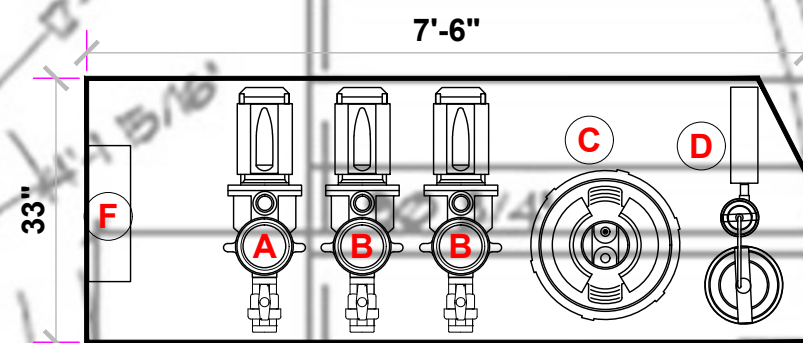
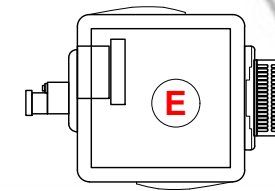

PLUMBING SLEEVES  
IN THIS AREA

**6** PRESTI  
Spa EQ (2) SCALE: 1/4" = 1'-0"



NESPA ENTERPRISES INC.

6/19/2021

Stainless Steel Trays

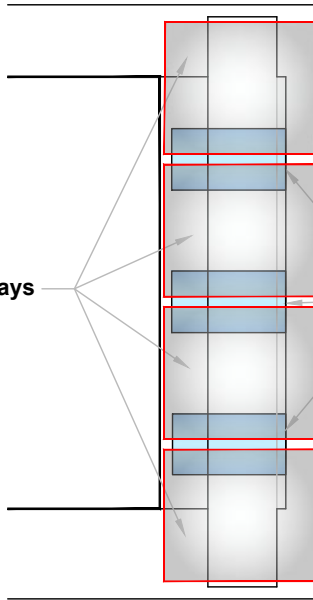

Steel Brackets

### Stainless Steel Trays

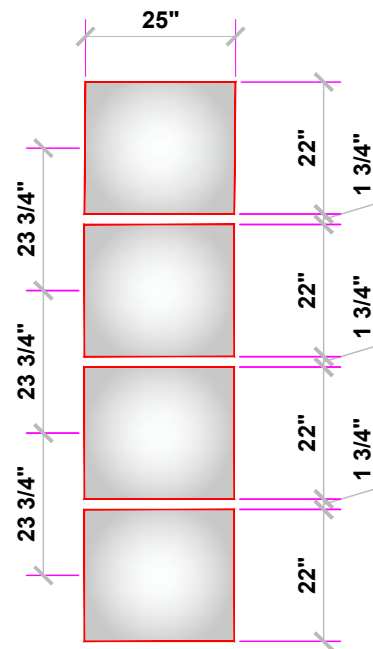

### Steel Brackets

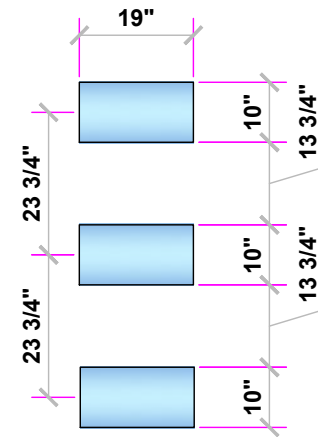

Removable Coping Stones

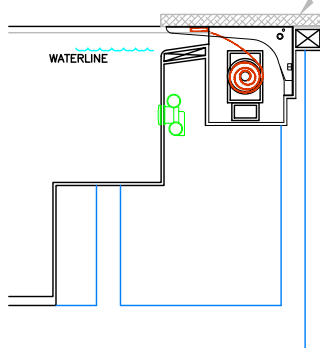

Auto Cover Color = CHARCOAL

### CoverStar Colors

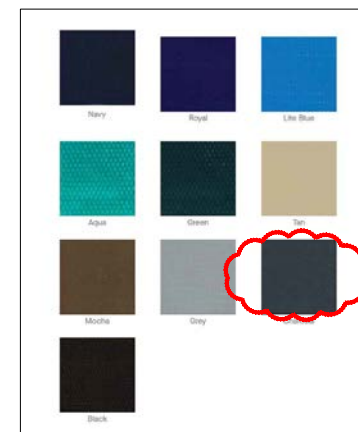

8

Auto Cover

PRESTI

SCALE: 3/8" = 1'



NESPA ENTERPRISES INC.

6/19/2021

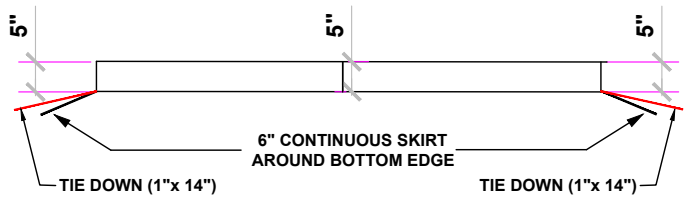
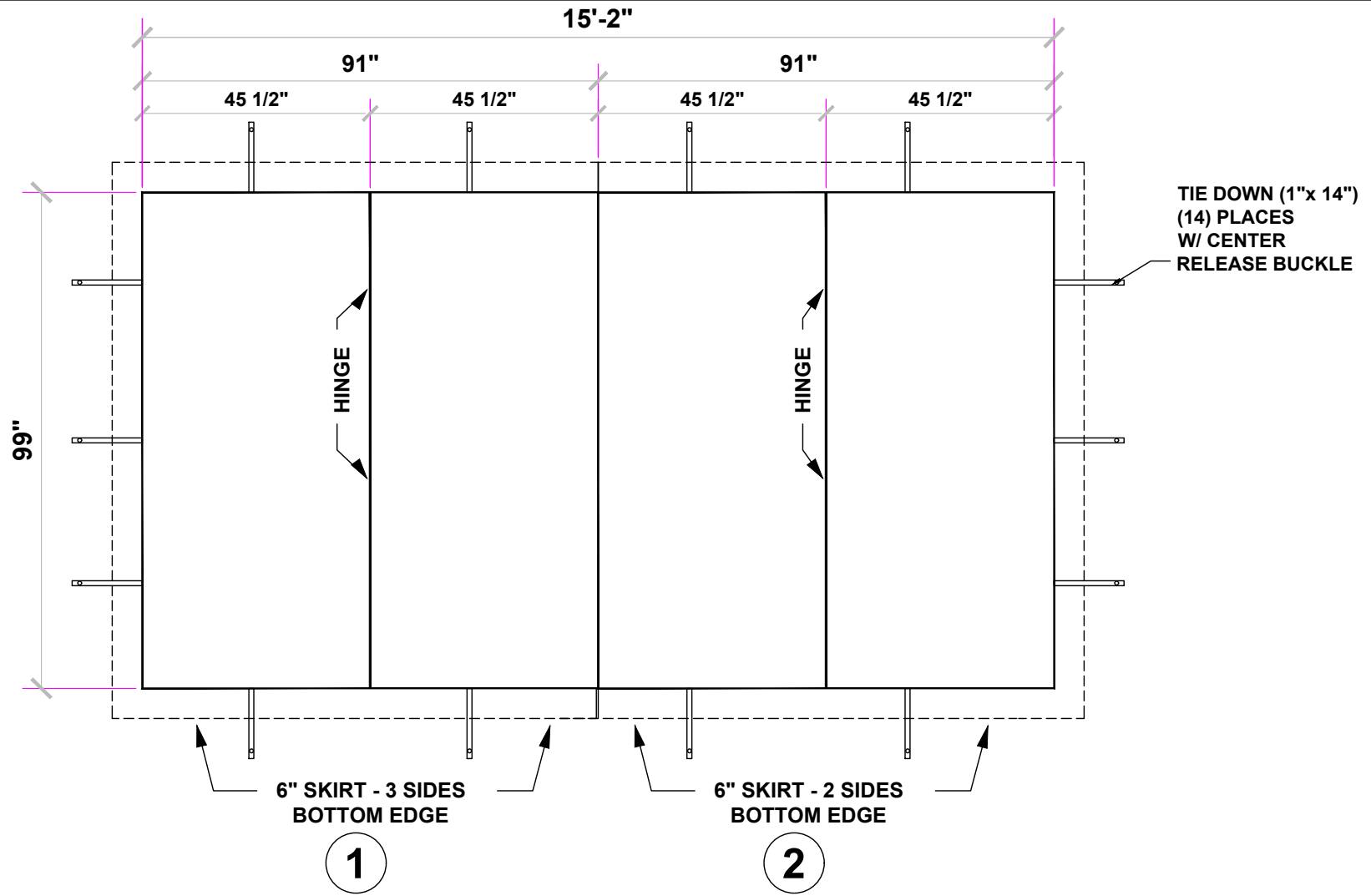

**SPA COVER #1220-A**  
**Color: CHARCOAL**  
**(2) - 2PC**  
**Hinged cover sets**  
 For: PRESTI

<b>9</b>	<b>PRESTI</b>
	SCALE: <b>3/8" = 1'</b>



NESPA ENTERPRISES INC.

6/19/2021

**Cover Box J-Box**

**NOTE:**  
Autocover Keypad to  
be placed remotely  
within sight of view  
of spa

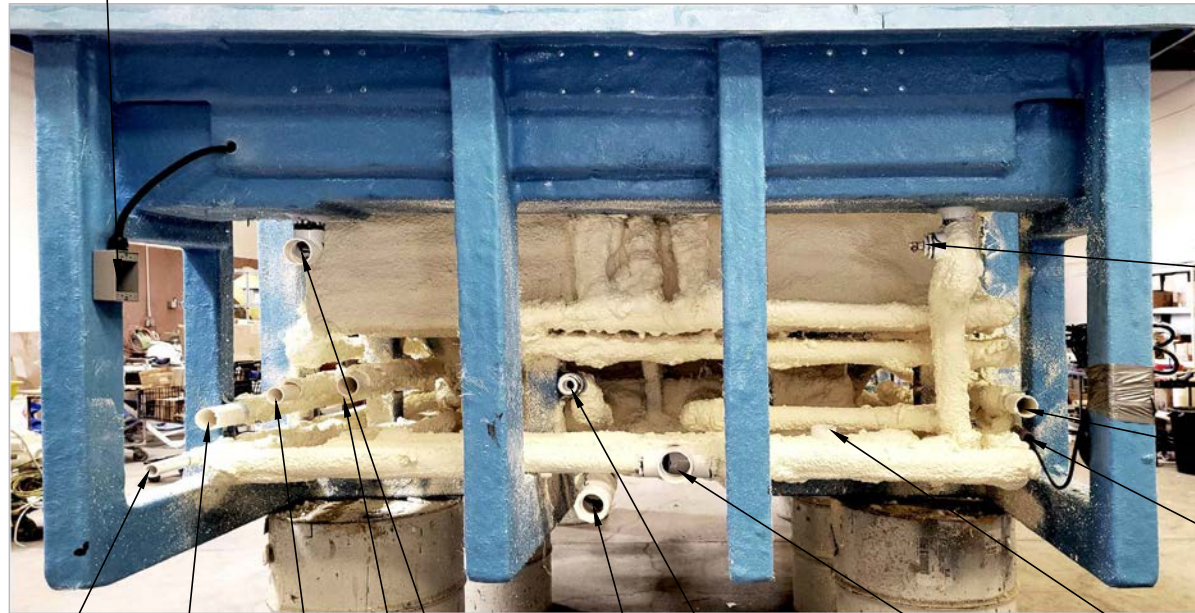
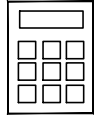

Leveler Stilling Line  
and Pool Bond

3" Jet Return Bank 1

1" Light Conduit

2" Filter Suction

2-1/2" Booster 1 Suction

1" Water Fill

2-1/2" Booster 2 Suction

Cover Box Drain

2" Filter Return

Skimmer Suction

3" Jet Return Bank 2

Spa Side Control

# STANDARD NESPA IN-GROUND INSTALLATION *INSTRUCTIONS* **SET-UP AND EXCAVATION**

**Prerequisites:** Before installing your Nespa spa. You may be required to acquire a permit from your local State, County, and City building dept and or Health department. (Commercial jobs need Health Dept. Approval). Your spa installation must comply with the most current codes. ( **Uniform Swimming Pool, Spas & Hot Tub Code 2006 ( USPC 2006)**).

**Spa drawings:** Request from Nespa a current spa specific construction detail, plan and section, spa plumbing detail.

**Delivery Access:** Clearly determine the method of getting the spa to jobsite and into the hole. This may require the use of a crane, forklift, hoist, backhoe and/or manpower etc.

- 1) The following instructions are general guidelines and may not apply to your specific jobsite conditions. When excavating for your spa remember to provide for plumbing and light connection clearances. In order to determine how to excavate for your spa or swim spa, measure spas outside dimension ( O.D.) and add minimum 3” to all sides. This 3” clearance is to accommodate jet and suction plumbing. This 3” clearance can change or be reduced upon request. Note: skimmer location, this area may have to be larger than 3”, if commercial 22”.
- 2) **Freeze Climates-** If the spa is place into a vault (typical of freeze climates) a standard 18” or more of clearance minimum from spa perimeter should be provided. This dead air space is for possible future access to spa plumbing in case of a freeze. Area drain is mandatory. **Ask your local installer** for his experienced opinion. Do not hesitate to call us because we want to be sure that your installation progresses as smoothly as possible. If you have questions call us. (888) 479-4677.
- 2) **Hole depth** is determined by spa’s outside height dimension. This height may vary depending if spa has skids or no skids. The spa lip may be finished or non- finished. How is the perimeter deck elevation transitioning to the spa? Focus on the finish surrounding deck elevations, thickness of the finish material on spa upper horizontal lip, equal to lip or under the spa lip. This material can be tile, stone, concrete or brick.
- 3) **Preplumb** the spa before it goes into the hole. If there are needs for electrical , bonding or control conduits run them as well before dropping in hole. Connect bond wire to niche would be best.
- 4) **Spa should sit on level 3 ½” thick reinforced concrete pad. Sweep debris off pad prior to dropping in hole.**
- 5) **Install spa** into the hole on top of concrete pad. Use the Eye bolts provided for crane, forklift etc. rigging. Do not hold onto pipes. Use caution with suction and jet plumbing when lowering into hole. **DO NOT STRESS FITTINGS!** Fill Spa with water and check for leaks prior to backfill.

- 6) **Check site reference** points for proper spa positioning (i.e., squaring to house, garage, etc.).
- 7) **Shim to level spa.** Shim with non-compression able material. Re square to house, or ref. point.
- 8) **Dry pack** with cement the gaps that have been created when shimming spa level.
- 9) **Connect pipes to tees** if spa is preplumb. Installers properly support your new plumbing from stressing spas preplumb fittings. After electrical conduit and bond wire is connected to light niche, water test spa before back filling with sand.  
**NOTE: All Nespa products are water tested prior to leaving factory.**

### **ELECTRICAL:**

- 1) All electrical connections to spa or equipment should comply with the most recent national electrical code (NEC), state and local codes.
- 2) Connect electrical conduit to light niche. This work should be done or reviewed by a licensed electrician.
- 3) To install spa light you will need to include inside the PVC conduit to the light niche a solid #8 coated copper wire. (If you are use brass conduit, internal bond wire is not required.) This bond wire should be pulled with the light cord at the same time. This bond wire needs to be attached to the internal bonding lug of the light niche. An approved encapsulate should be applied to bond wire connection in niche.
- 4) An external #8 copper wire shall be connected to the external bonding lug on the rear of the light niche. This copper wire can then be used for additional bonding requirements (i.e., handrails or any other metallic object within 5' of the spa.

### **PLUMBING:**

- 1) **When plumbing a Nespa it is important to properly size the plumbing. We highly recommend that you follow the pump manufacturer's pipe sizing requirements and Uniform Swimming Pool, Spas & Hot Tub Code 2006 ( USPC 2006). This code book is available at [www.JAPMO.org](http://www.JAPMO.org) or (909) 472 4100.**
- 2) The jet air venturi should be a Hartford loop design adjacent to spa shell and air entry point can be located next to spa or remotely at equipment.
- 3) Fill spa with water and test the system for leaks PRIOR to backfilling with sand.

### **SAND BACK FILL:**

- 1) **With water in spa, back-fill around spa perimeter with dry plaster sand and wet wash with hydraulic attachment to hose. Let set for one hour and hydraulic dry again. Be sure water level in spa is at the highest level. Any questions please call us. ( 888) 479-4677.**
- 2) **If spa is free standing on elevated deck or a structure, it is important to fill spa with water and load area prior to installing coping or perimeter decking. If spa is installed in a vault situation a area drain is needed.**

## **NESPA ENTERPRISES, Inc. LIMITED WARRANTY**

**This LIMITED WARRANTY covering NESPA products is extended to the ORIGINAL PURCHASER-USER BY NESPA ENTERPRISES Inc.(NESPA), 2800 Richter Ave. Unit C California 95966.**

**NESPA products are thoroughly inspected and tested prior to factory shipment. NESPA warrants to the ORIGINAL PURCHASER-USER that NESPA Spas and Swim Spas will be free of defect in workmanship, accessories and parts, provided said accessories and parts were manufactured by NESPA. NESPA, under this LIMITED WARRANTY, warrants only that its Spas and Swim Spas shall be structurally sound, shall retain their shape, and shall retain water for the warranty period. NESPA warrants the adhesion of tile to fiberglass for a period of three (3) years and structural soundness for ten (10) years. NESPA warrants epoxy grout adhesion for a period of three years. If any such defects appear and are reported within the warranty period, NESPA shall repair or replace such defective parts without charge if an inspection proves the claim.**

**The provisions of the LIMITED WARRANTY shall not apply to tile cracked, split, chipped or damaged after the product has left the factory, nor damage to tile caused by freezing nor to damage, defect, malfunction or failure to conform with the above warranty provisions where the damage, defect, malfunction or failure to conform was caused during shipment or by distributor or by unreasonable use by ORIGINAL PURCHASER-USER including improper water balance and improper sand pack or support.**

**This LIMITED WARRANTY shall not apply to any plumbing, equipment, or installation of spas and Swim Spas and shall not apply to any alterations made to or upon NESPA products except alterations made by NESPA employees or NESPA authorized representatives.**

**This LIMITED WARRANTY is expressly in lieu of all other warranties expressed or implied including the warranties of merchantability and fitness for use and all other obligations or liabilities on NESPA'S part, and NESPA neither assumes nor authorizes any other person to assume for NESPA any other liability in connection with the sale of this NESPA product. This LIMITED WARRANTY shall not apply to this NESPA product or any part thereof which has been subject to accident, negligence, alteration, abuse or misuse. NESPA makes no warranty whatsoever with respect to accessories or parts not manufactured by NESPA.**

**The term "ORIGINAL PURCHASER-USER" as used in this LIMITED WARRANTY shall be deemed to mean that person for whom the NESPA product is originally installed.**

**The LIMITED WARRANTY provided herein and the obligations and liabilities of NESPA hereunder are exclusive and are in lieu of, and buyer and original PURCHASE-USER hereby waive all other remedies, warranties, guarantees or liabilities, expressed or implied, arising by law or otherwise (including without limitation and obligations of NESPA with respect to fitness, merchantability, and consequential damages) or whether or not occasioned by NESPA'S negligence.**

**This LIMITED WARRANTY shall not be extended, altered or varied except by a written instrument signed by NESPA and original PURCHASER-USER.**